

Available Top Slabs

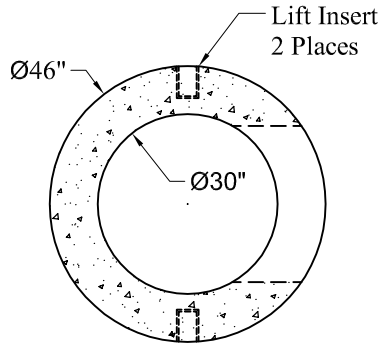

30" Drop Inlet Riser

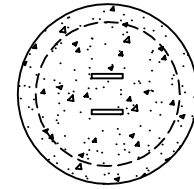

Optional Concrete Plug

Dim 'B'	Est. Weight:
12"	1,000 Lbs
18"	1,500 Lbs
24"	2,000 Lbs
30"	2,500 Lbs
36"	3,000 Lbs

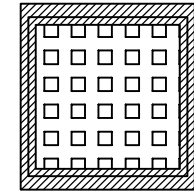
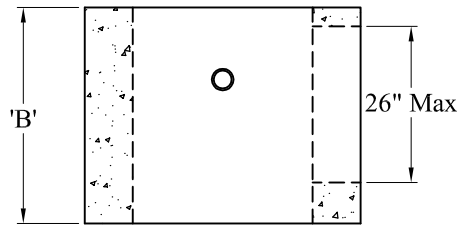

Optional Cast Iron Frame & Grate

Dim 'A'	Est. Weight:
24"	2,215 Lbs
30"	2,710 Lbs
36"	3,200 Lbs

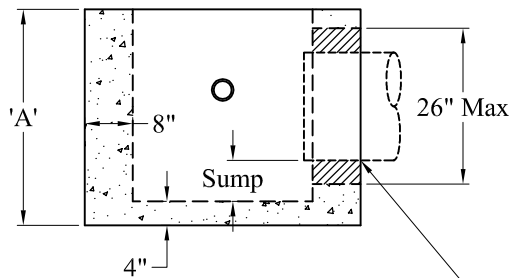

30" Drop Inlet Base

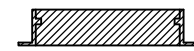
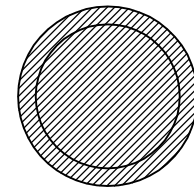

Optional Cast Iron Frame & Cover

Mortared or Booted Connection

**General Notes**

- 1.) Concrete:  $f_c = 4,000$  psi @ 28 Days Minimum
- 2.) Design Loading: AASHTO-HS20-44
- 3.) Sump As Required

Phoenix  
Precast  
Products

30" Diameter  
Area Drains