

Plan View

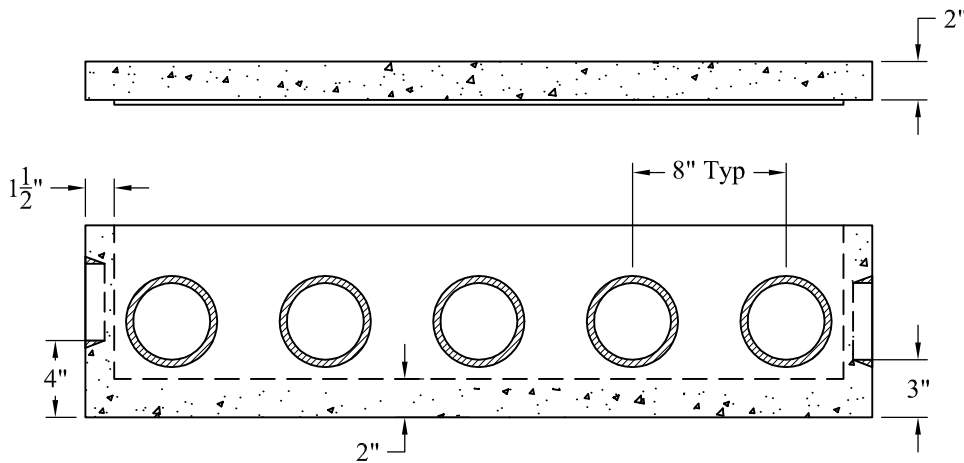

Section View

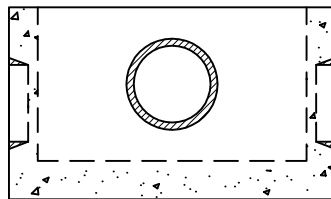

Inlet End

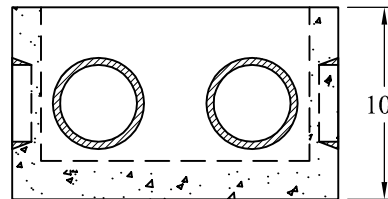

Outlet End

General Notes

- 1.) Concrete: $f_c = 4,000$ PSI @ 28 Days Minimum
- 2.) Plastic Pipe Seals On All Openings
- 3.) Est Weights:
 - Box: 196 Lbs
 - Cover: 112 Lbs
 - Total: 308 Lbs

Phoenix
Precast
Products

12 Outlet
"D" Box

P/N: DB-12