

1-800-639-2199

Fax (603) 224-2927

Steps

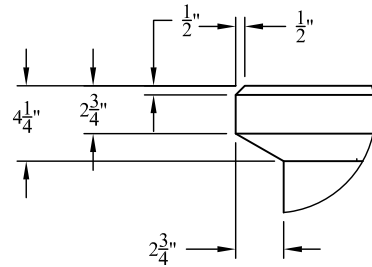
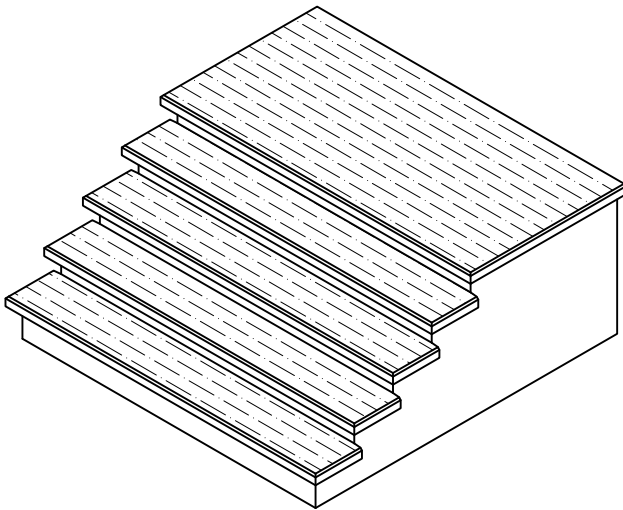

DETAIL B
SCALE 1 : 10

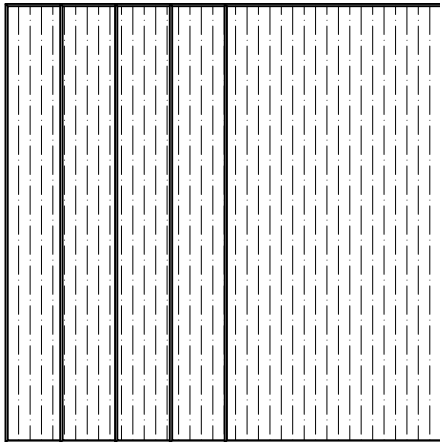

Phoenix Precast Products

Phoenix Precast Products

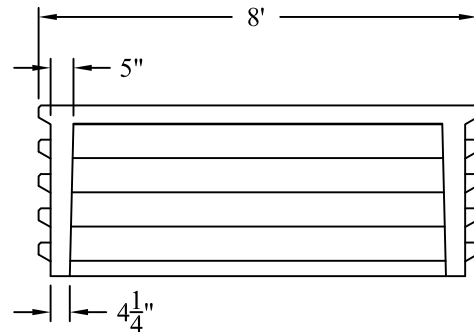
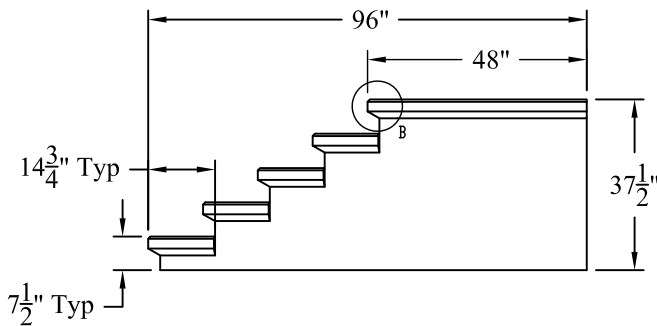

Est Weight: 3,990 Lbs

General Notes

- 1.) Concrete: $f_c = 4,000$ PSI Minimum After 28 Days Minimum
- 2.) Broom Finish Supplied
- 3.) Blocks and Angles Attached To Poured Foundation By Phoenix Precast
- 4.) Optional Concrete Slab, Sono Tubes or Compacted Crushed Gravel By Others

Phoenix
Precast
Products

8Ft Wide
5 Riser

P/N: PS-8WX5R

Concord, NH 03301