

1-800-639-2199

Fax (603) 224-2927

Headwall\Standard\Straight\Dual 15in Phoenix Standard HW (v)

Phoenix Precast Products

Phoenix Precast Products

1" Chamfer All Exposed Surfaces

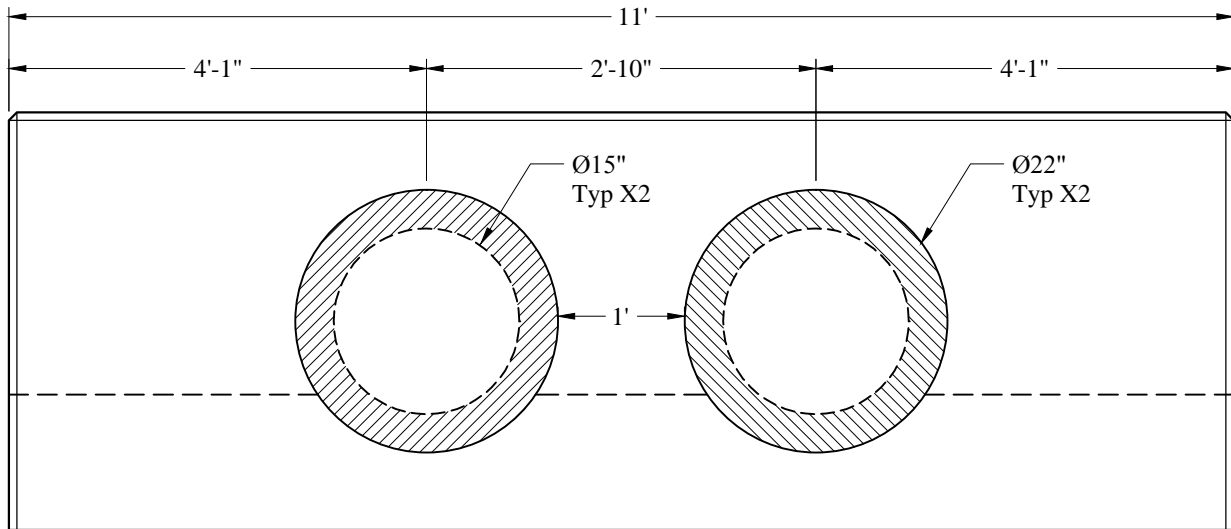
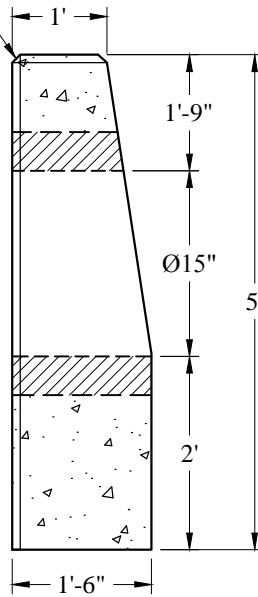

General Notes

1. Steel Reinforcement Conforms to Latest ASTM Specification: ASTM A-615 Grade 60 Black Deformed Bars
2. Concrete: $f_c = 4,000$ psi @ 28 Days Minimum
3. Est Weight: 10,000 Lbs

Phoenix
Precast
Products

Phoenix Standard
Dual Headwall
15" Pipe

P/N: HW-D15