

Phoenix Precast Products

Phoenix Precast Products

Pipe Chart			
	Pipe	Pipe OD	Connection
E			
I			
F			
D			

Elevation Chart		
	Description	Elevation
R	Rim	
G	Finish Grade	
E	Electric Connection(s)	
I	Inlet	
F	Force Main Outlet	
D	Drain Back to Pump Station	
B	Inside Bottom Floor	
C	Outside Bottom of Concrete	
W	Top of Wall	
T	Top of Concrete	

- 1.) Steel Reinforcement Conforms To Latest ASTM Specifications: ASTM A-615 Grade 60 Black Deformed Bars
- 2.) Concrete: $f_c = 5,000$ PSI @ 28 Days Minimum, Type III Cement
- 3.) Butyl Rubber Joint Sealant Conforms to ASTM C-990 and Federal Spec SS-S-210A.
- 4.) Flexible Connection Provided For All Pipe Connections. See Table.
- 5.) All Valves, Mounting Hardware, and Related Ancillary Equipment Provided by Others.
- 6.) AASHTO-HS20-44 Design Loading Conforms to Latest Specifications ASTM C 890 & C 913
- 7.) Hatch to Drain Into Vault Unless Otherwise Noted
- 8.) Bouyancy Calculations Provided With Shop Drawing Submittal
- 9.) Optional Asphalt Coating Applied to All Exterior Surfaces Except Top Slab
- 10.) Optional Aluminum Ladder Available

- Options:
- LinkSeal Pipe Connections
 - LinkSeal Electrical Connections
 - Exterior Damp Proofing/Water Proofing
 - Interior Coatings
 - Sloped Floor
 - Exterior Joint Wrap
 - Safety Net, Safety Grate
- Est Weights:
- Top Slab: 2,500 Lbs
 - Risers: 1,332 Lbs/VF
 - Sloped Floor: 1,200 Lbs
 - Base Slab: 1,850 Lbs

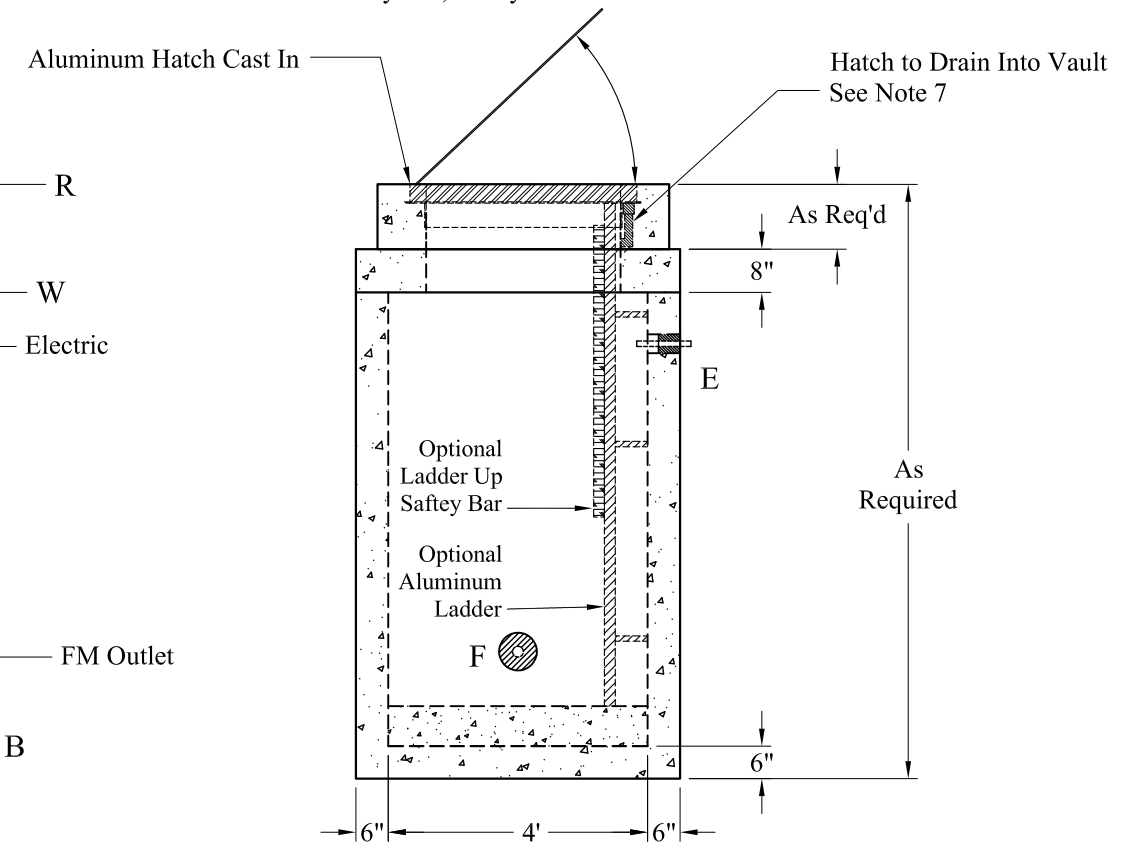
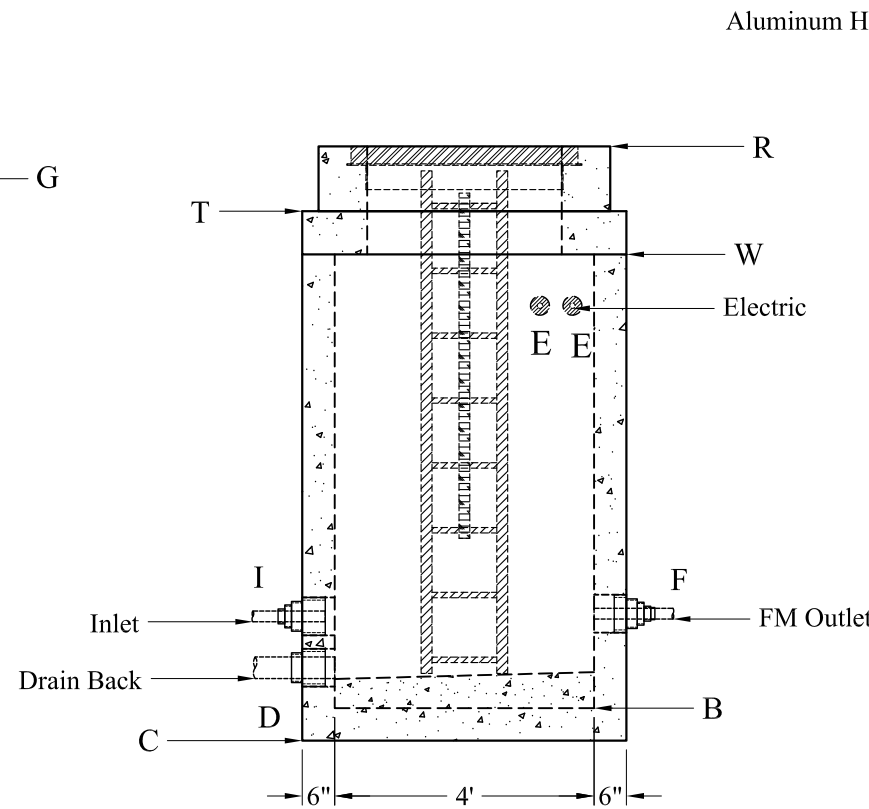
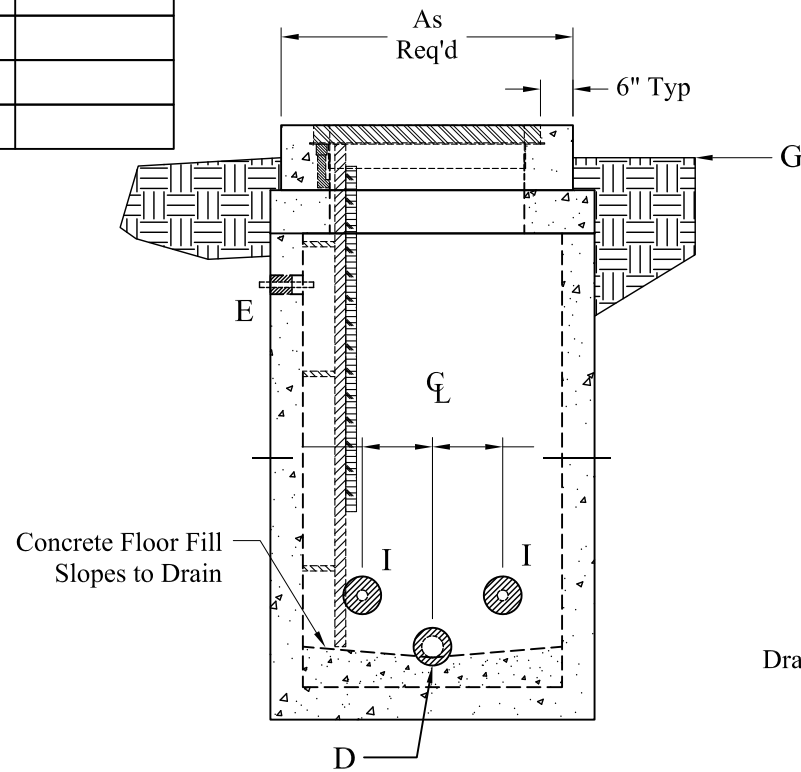
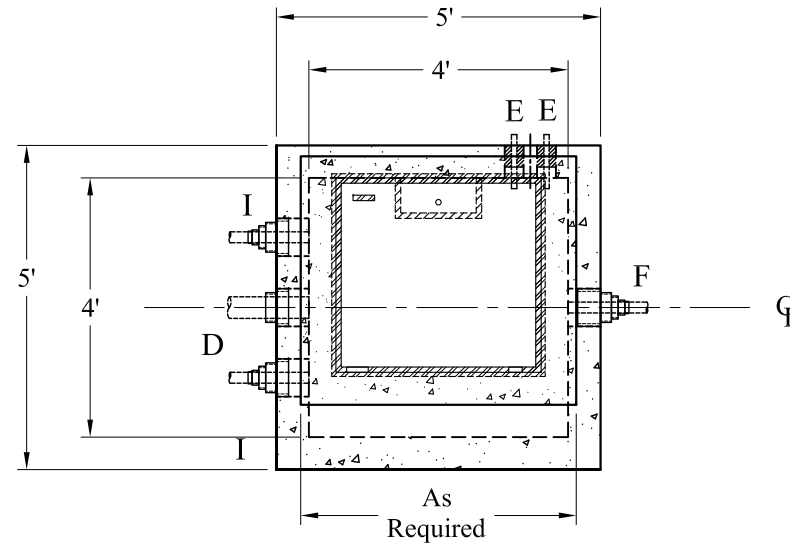

<p>Phoenix Precast Products</p>	<p>Typical 4' x 4' Valve Vault</p>
<p>P/N: Custom As Required</p>	